

SECTION A-A

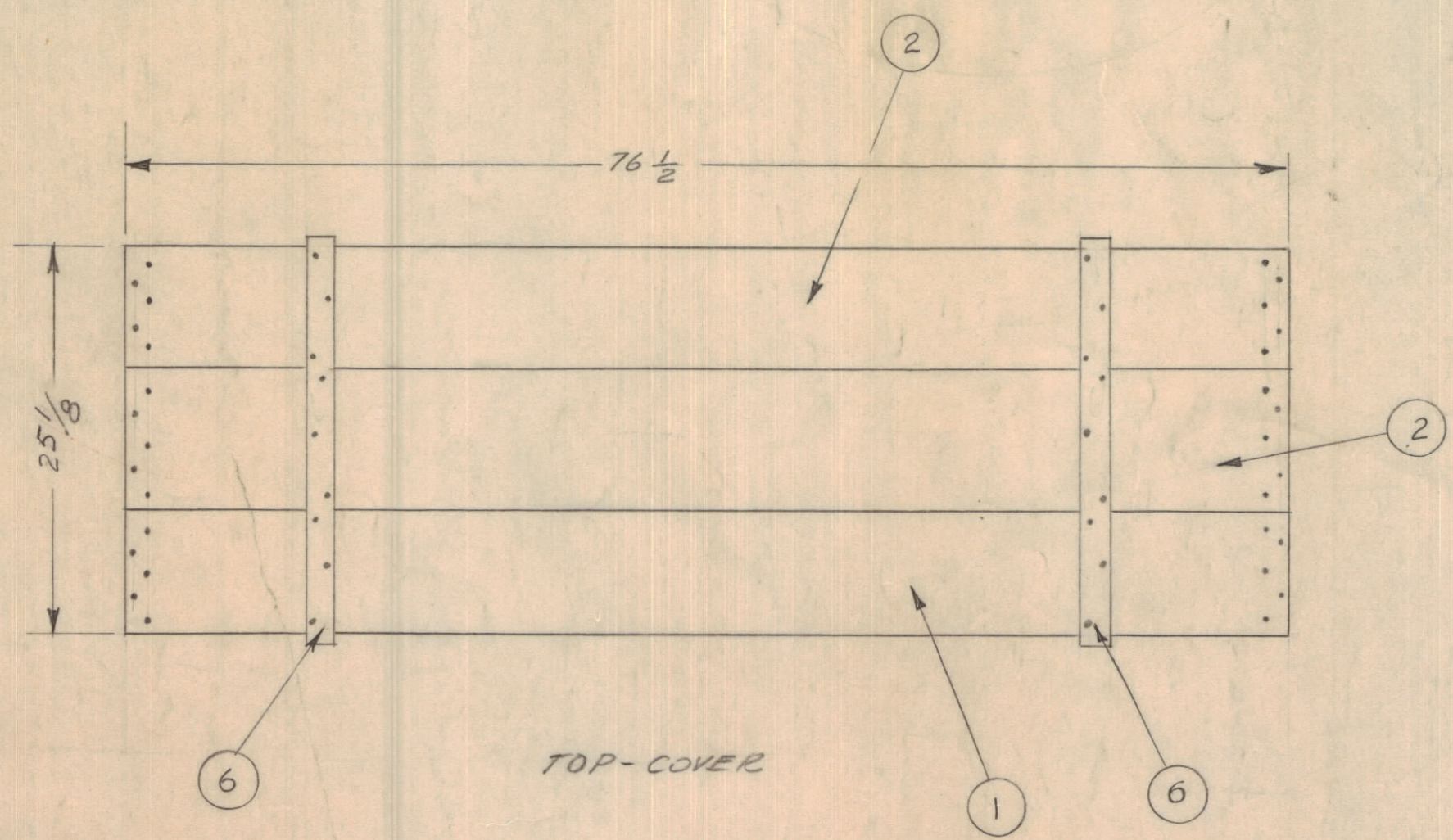

TOP-COVER

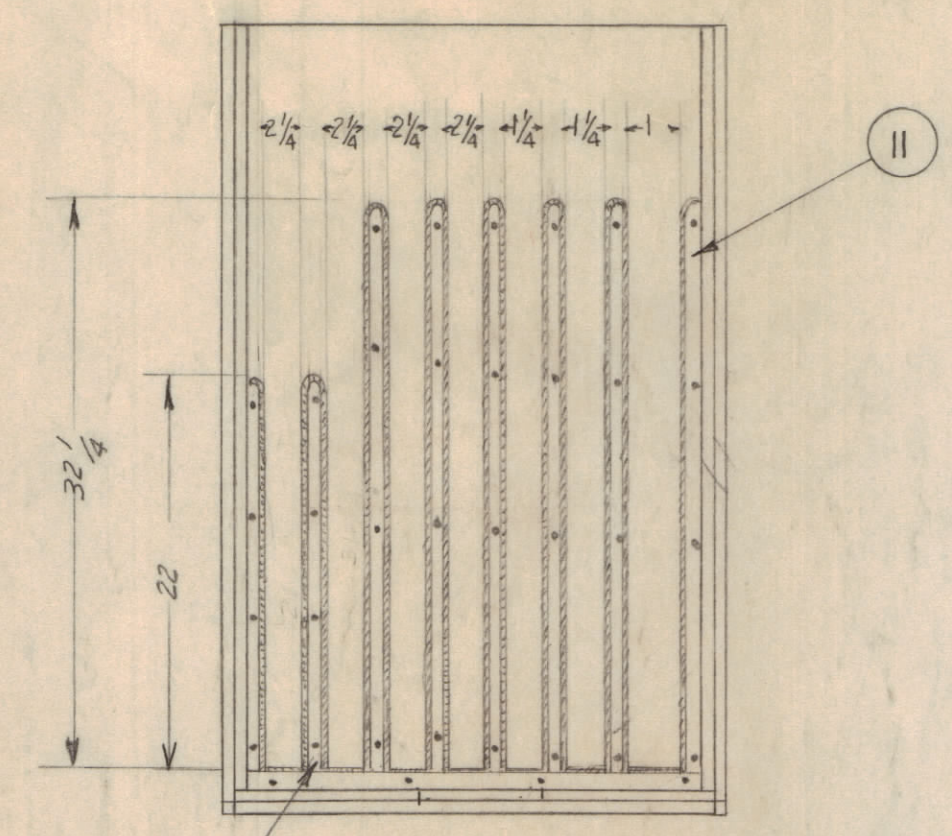

SECTION B-B

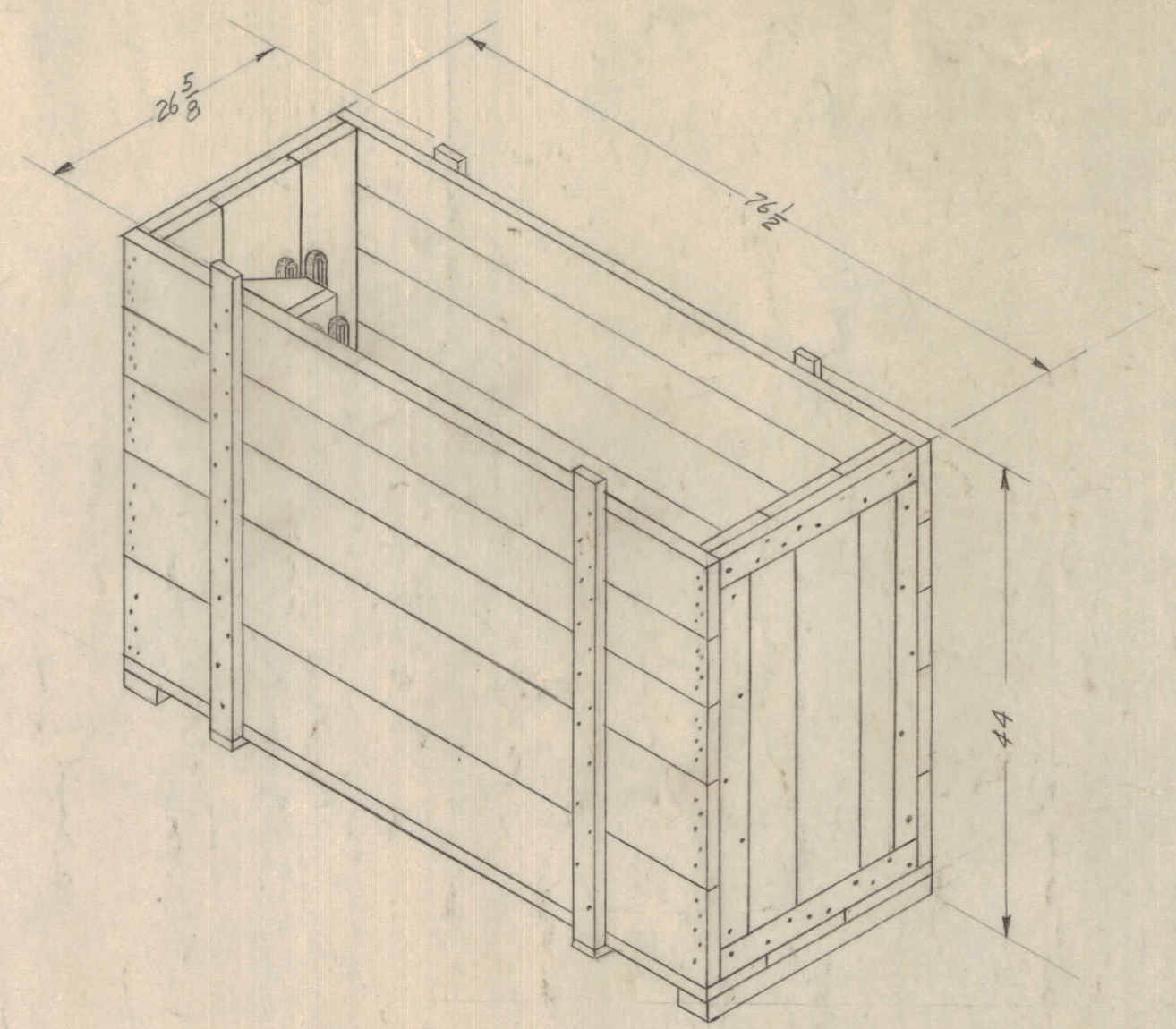

ISOMETRIC OF BXW-103 SHOWN W/COVER REMOVED

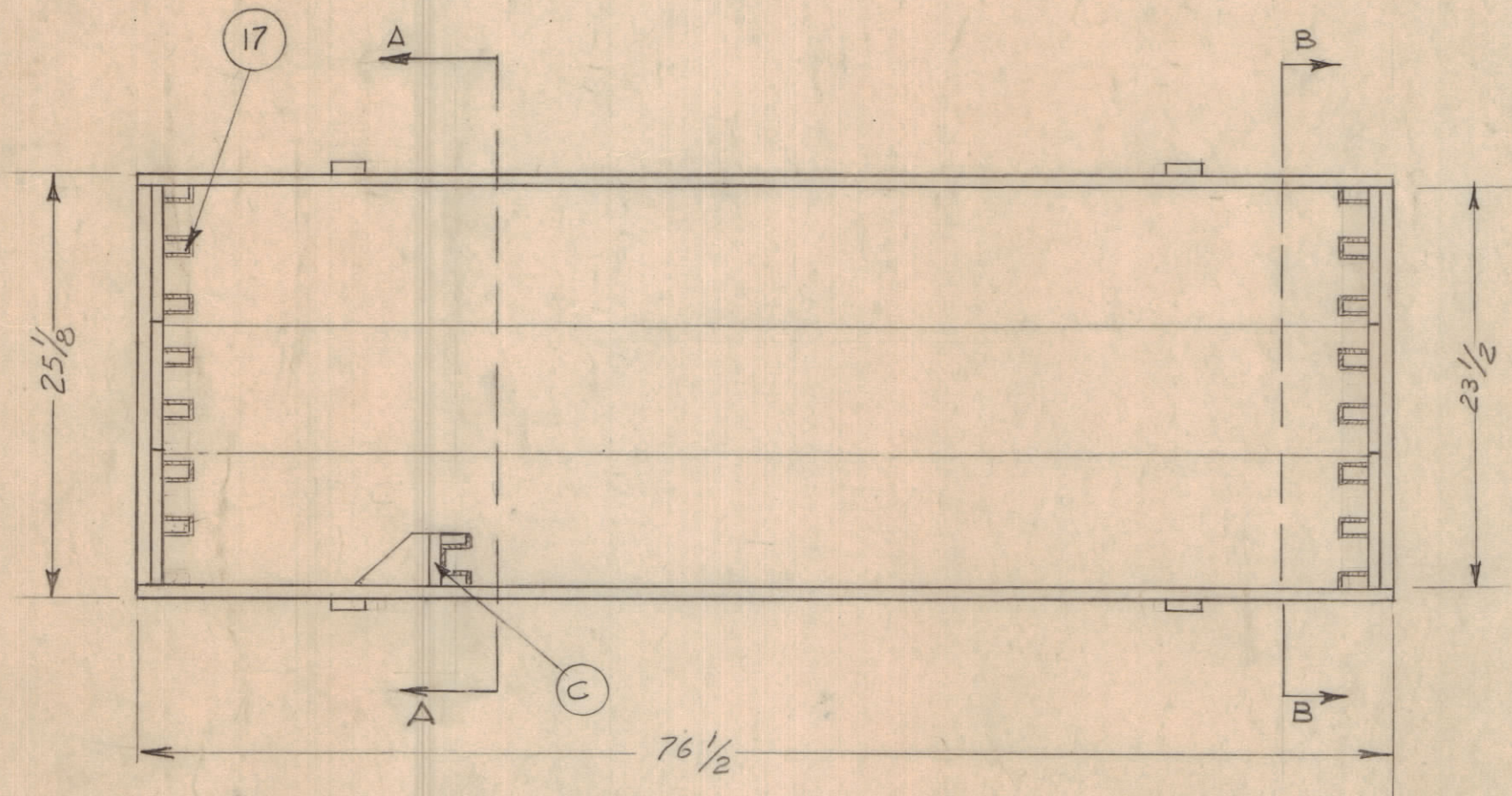

TOPE VIEW W/COVER REMOVED

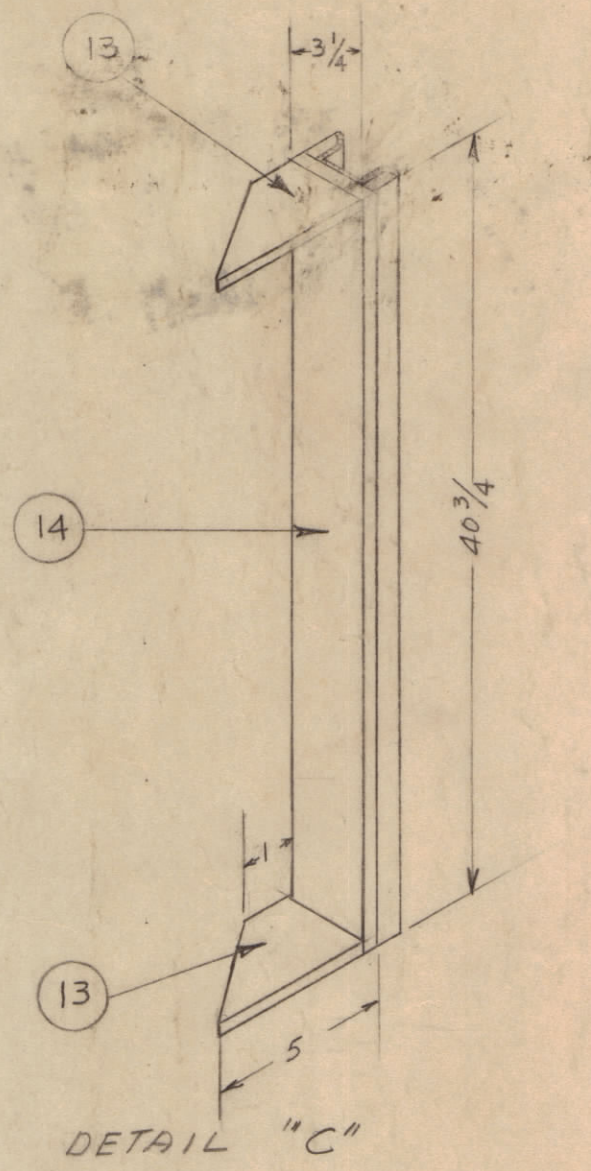

DETAIL "C"

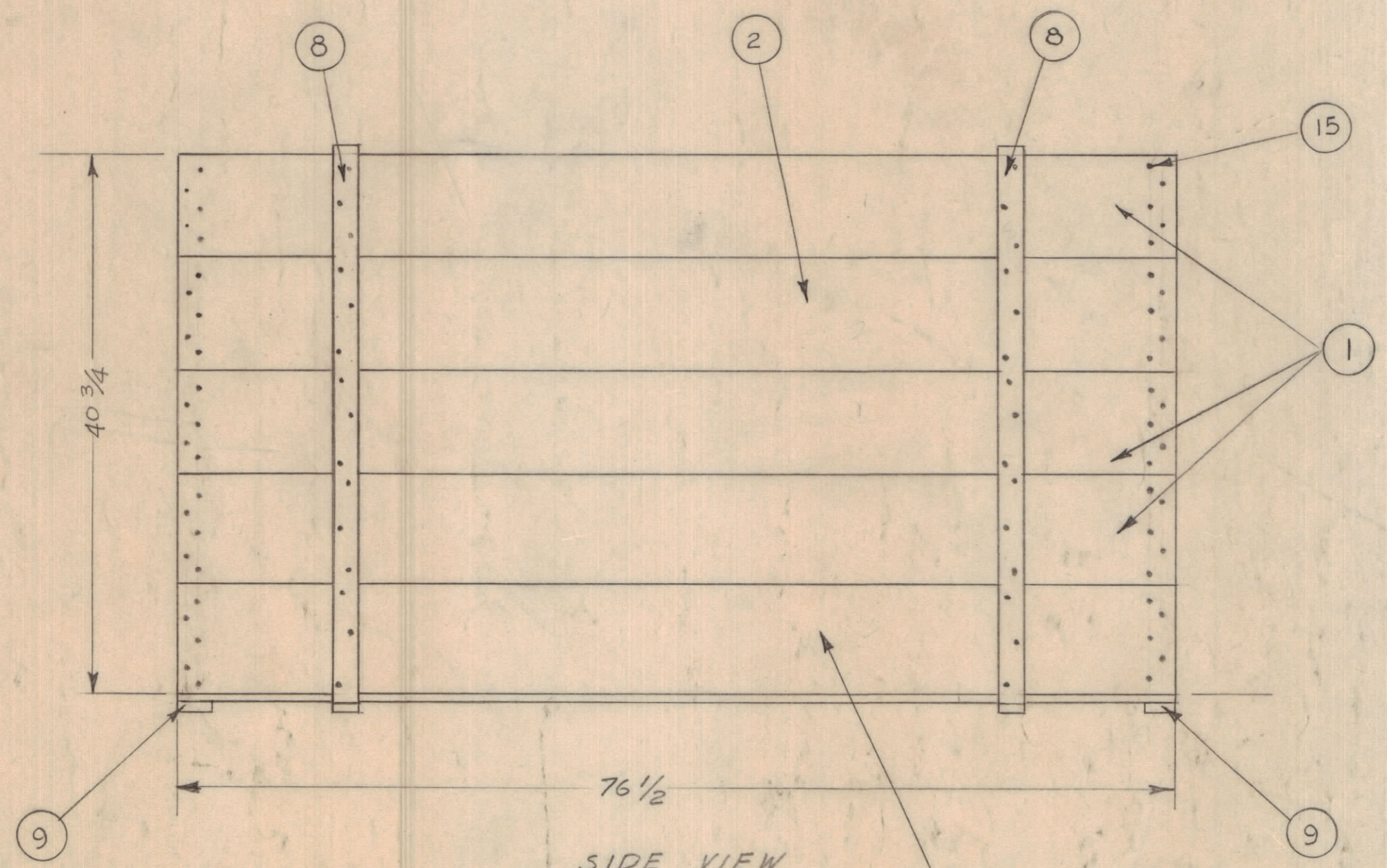

SIDE VIEW

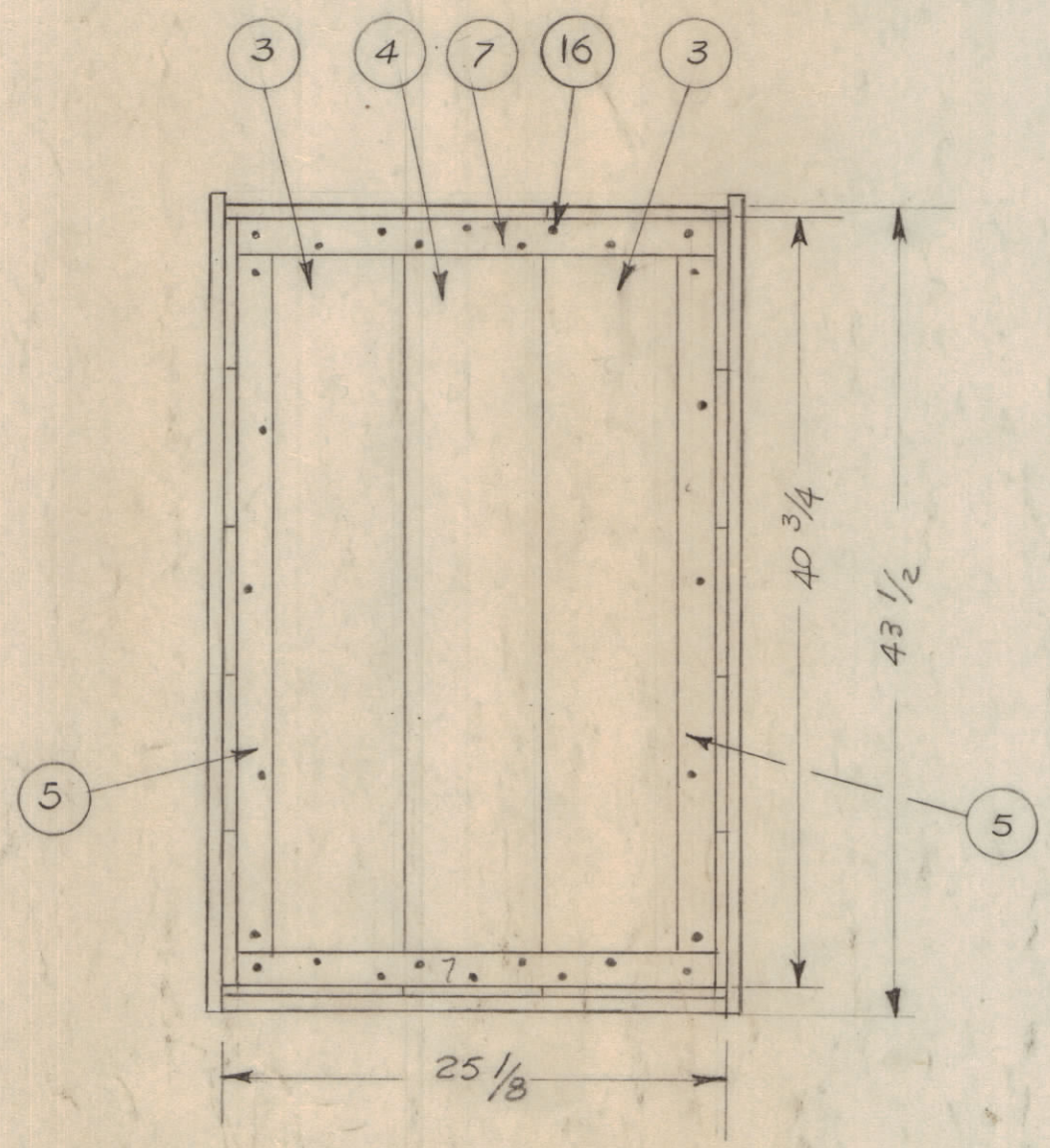

END VIEW

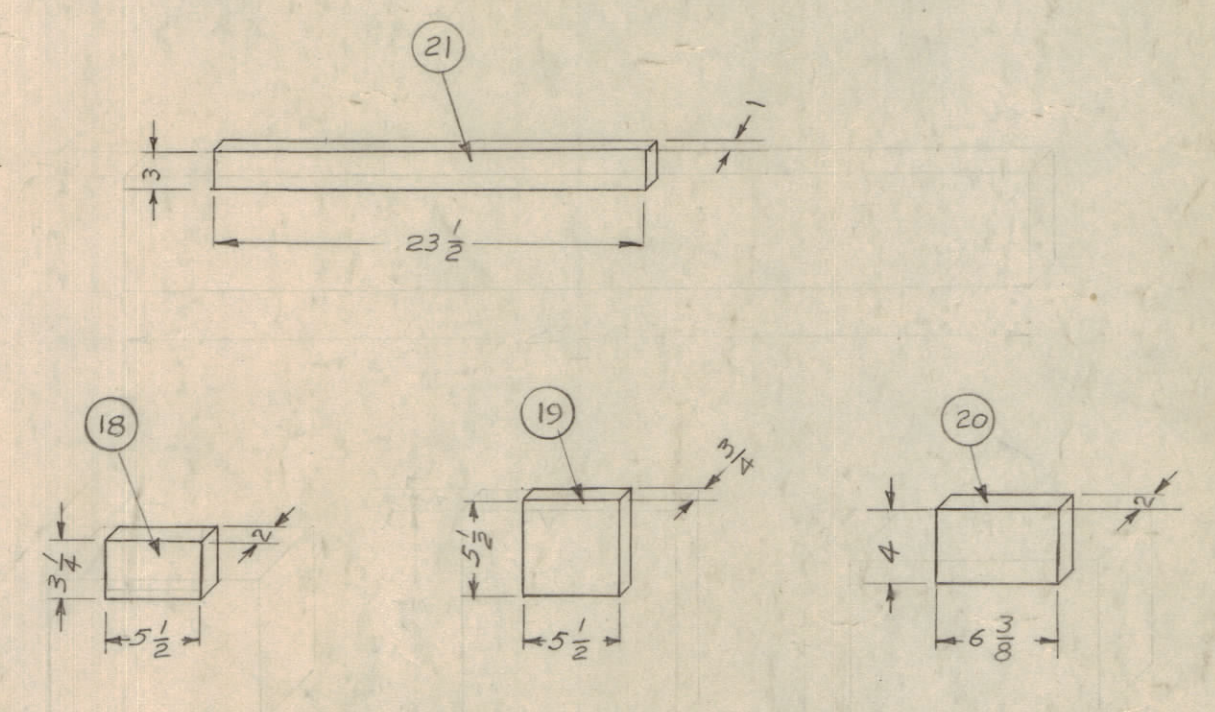

REQ.	ITEM	PART NO.	DESCRIPTION	SYMBOL
3	21	WD-23 1/2-3-1-P3-CD	BATTEN, PINE, PONDEROSA	
8	20	WD-6 3/8-4-2-53-CD	BATTEN, SPRUCE, GRADE 3	
2	19	PLY-5 1/2-5 1/2-3/4-F-A	BATTEN PLY WOOD	
2	18	WD-5 1/2-3 1/4-2-53-CD	BATTEN, SPRUCE, GRADE 3	
794	17	TA-104-2	TAPE POLURETHANE FOAM	
160	16	NA-101-12	NAILS 6 PENNY	
251	15	NA-101	NAILS 8 PENNY	
1	14	WD-40 3/4-3 1/4-1-P3-CD	PINE PONDEROSA, GRADE 3	
2	13	WD-5 3/4-1-1-P3-CD	PINE, PONDEROSA, GRADE 3	
2	12	WD-39-2-1-53-CD	SPRUCE, GRADE 3	
11	11	WD-32 3/4-2-1-53-CD	SPRUCE, GRADE 3	
4	10	WD-22-2-1-53-CD	SPRUCE, GRADE 3	
2	9	WD-25 1/8-4-1-P3-CD	PINE, PONDEROSA, GRADE 3	
4	8	WD-40 3/4-3-1-53-CD	SPRUCE, GRADE 3	
4	7	WD-23 3/8-3-1-53-CD	SPRUCE, GRADE 3	
4	6	WD-26 5/8-3-1-53-CD	SPRUCE, GRADE 3	
4	5	WD-38 3/4-3-1-53-CD	SPRUCE, GRADE 3	
2	4	WD-40 3/4-8-1-P3-CD	PINE, PONDEROSA, GRADE 3	
4	3	WD-40 3/4-10-1-P3-CD	PINE, PONDEROSA, GRADE 3	
6	2	WD-76 1/2-10-1-P3-CD	PINE, PONDEROSA, GRADE 3	
10	1	WD-76 1/2-8-1-P3-CD	PINE, PONDEROSA, GRADE 3	

SYM.	ZONE	DESCRIPTION	DATE	CH. NO.	DRAFTS	CHECKER	ENG. APP.
UNLESS OTHERWISE SPECIFIED:		SCALE					
DIMENSIONS ARE IN INCHES		MAXIMUM ALLOWABLE TOLERANCES HAVE BEEN DETERMINED AND ANY DEVIATIONS WILL BE CAUSE FOR REJECTION. REMOVE ALL BURRS & SHARP EDGES					
TOLERANCES ON FRACTIONS ± 1/64		DECIMALS ± .005		ANGLES ± 1/2°			

REQ. PER UNIT	MODEL	SECTION	ASSY. NO.	USED ON
1	GPT-40K			
1	GPT-10K			

REQ.	ITEM	PART NO.	DESCRIPTION	SYMBOL
TMC INDUSTRIAL CORP. MAMARONECK, NEW YORK				
BOX, WOODEN				
DRAWN		CHECKED		FINAL APPROVAL
TYPE & TEMPER		HEAT TREAT. SPEC.		
FINISH & SPEC. NO.		ELEC. DES. APP.		MECH. DES. APP.
		SHEET		OF

BXW-103

A